

User Guide

PARADOX

MAGELLAN

READY TO ARM
MENU

- 1-BYPASS ZONES
- 2-ALARM CLOCK
- 3-TIME AND DATE
- 4-SYSTEM SETUP

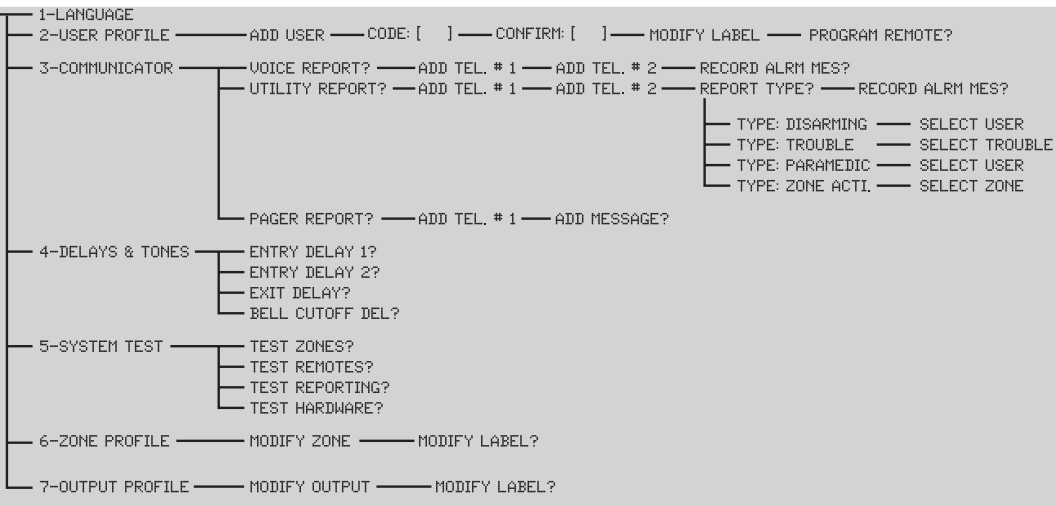

- 5-CHIME ZONE
- 6-ALARM MEMORY
- 7-HISTORY LOG
- 8-UTILITY SETUP

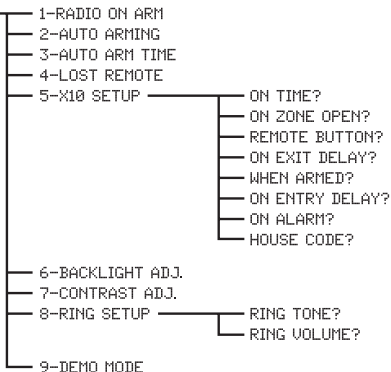

User Menu Overview

MAGELLAN™

User Menu Overview

 = SYSTEM MASTER ONLY

Table of Contents

Overview.....	2	Trouble Display.....	23
Introduction	3	Making a Service Call.....	24
Basic Operation	6	Demo Mode	24
Arming / Disarming	9	X10 Automation	24
Arming.....	9	Access System Features by Phone.....	25
Disarming.....	12	Access System Features by Phone.....	25
Fire Alarms.....	13	Advanced Features	27
Panic Alarms.....	16	Programming User Codes	27
Consumer Features.....	18	Adding a Remote Control to an Existing User ...	28
Message Center.....	18	Setting the Language	29
FM Radio Feature	19	Voice Reporting	29
Alarm Clock.....	20	Utility Reporting	30
Speakerphone.....	21	Pager Reporting	31
Chime Zones.....	22	Bell Cut-Off Timer.....	32
Keypad Settings.....	22	System Test.....	32
Time and Date	23	Zone Labels.....	32
Programmable Outputs (PGMs)	23		



Chapter 1: Overview

What's in this chapter:

- Introduction
- Basic Operation

This chapter will give you a basic overview of your Magellan system. It will cover Magellan's light indicators, keypads and remote controls. This chapter also includes sections explaining how to use this guide as well as a list of conventions used throughout the manual.

Introduction

Magellan is the first security system to combine security with popular consumer features and a stylish design. Magellan looks different from anything else in the security industry. Install it anywhere in your home or small business—Magellan blends beautifully with any décor. Listen to the radio, leave a message or use your system as a telephone, alarm clock or monitoring device.

Magellan consists of wireless detection devices installed at specific entry and exit points, as well as other vulnerable areas, such as windows. These devices protect the premises and communicate with Magellan's main console. If you have armed the system and a device detects a breach, a siren will be activated and your monitoring station will immediately be notified by phone. Choose from wireless motion detectors with pet immunity, door contacts, and remote controls that automate your most frequently used security functions.

With Magellan you have security and so much more:

- Built-in FM radio (page 19)*
- Speakerphone (page 21)*
- Family message center (page 18)
- Telephone access to system features (page 25)*
- Alarm clock (page 20)
- Chime zones (page 22)
- Voice, Utility and Pager reporting (page 29 to page 31)
- One-touch arming (page 11) and panic keys (page 16)
- Full, Force, Stay, Instant and Automatic arming (page 9)**
- X10 home automation (page 24)*
- 16 wireless zones, 16 remote controls and 16 users available

* Available with the MG-6060 only.

** Please note that Force arming and Auto-arming are not for use in UL installations.

How to Use this Guide

This manual employs an icon-based instruction format to display the steps required to use Magellan's features. The icon-based instructions are designed to be used in conjunction with the on-screen instructions being displayed on the Magellan console. In other words, as you are following the instructions shown in this guide, you should also be reading what is being displayed on the LCD screen. All of the icons displayed in this guide are explained in *Conventions* on page 5.

Example

When setting the Magellan console's time and date (page 23), the following will be displayed:

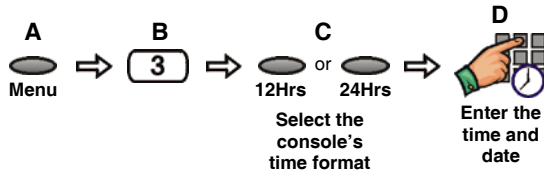









A- Press the **[MENU]** action key (the right action key located under the right side of the LCD screen).









B- Press the **[3]** key on the main keypad.

C- Select the time format that Magellan will follow; press the **[12HRS]** action key (the left action key under the LCD screen) to select the 12-hour format or the **[24HRS]** action key (the center action key under the LCD screen) to select the 24-hour format.

D- Program the desired time (following the time format selected before) and then the date.

Conventions

Icon	Definition
	Reference to another manual or guide.
	Warning or important information.
	Reminder or suggestion.
[DATA] or [KEY]	Type required data or press the designated key on either the main or center keypad.
	Record voice label when prompted or speak into the Magellan console when using Magellan's Speakerphone feature (see page 21).
	Press the specified action key. See Figure 1 on page 6.
	Press the specified key on the main keypad. See Figure 1 on page 6.
FM  	Press the specified function key. See Figure 1 on page 6.

Icon	Definition
	Enter the System Master code on the main keypad.
	Enter your User code on the main keypad.
	Enter a time value (such as when programming Magellan's date and time) on the main keypad.
	Enter numerical data for the specified feature on the main keypad.
	Press a button on a remote control.
	Wait the specified amount of time before performing another action.
	Call Magellan through a standard touch-tone telephone.
	Press any key on the console.

Basic Operation

Figure 1: Basic Overview

Light Indicators:

 Orange **INFORMATION** light
ON: There is a trouble in the system, an alarm has just occurred or a zone has been bypassed.
Flashing: There is a power failure and the Magellan console is receiving no power.

 Red **ARMED** light
ON: System is Regular armed.
Slow Flashing: System is Stay armed.
Rapid Flashing: System is in alarm.

 Green **READY** light
ON: All zones closed. System can be armed.
Flashing: System in Exit Delay mode.

 Orange **MESSAGE** light
Flashing: A voice message has been recorded. See *Message Center* on page 18.

Function Keys

 Message Key
Press once: Play a recorded voice message.
Press & hold: Record message. See page 18.

FM  Radio Tuner / Alarm Clock Key
Press once: Turn ON/OFF radio*. See page 19.
Press & hold: Enable/disable alarm clock. See page 20.

 Stay Arming Key
Press once: Enter user code to Stay arm
Press & hold: One-touch Stay arm. See page 10.

 Regular Arm Key
Press & hold: One-touch Regular arm. See page 9.

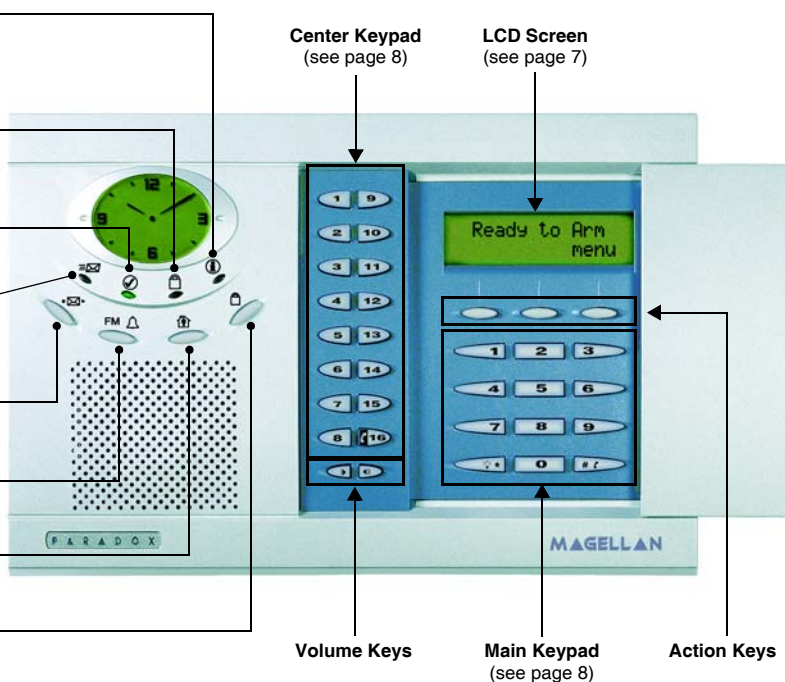

* = MG-6060 only

LCD Screen

Information symbol. This means:

- There is a trouble in the system (see page 23).
- There is an alarm in memory (see page 13).
- Zones or a zone is currently bypassed (see page 10).

Alarm clock feature enabled (see page 20).



Instructions and/or messages appear in this line

The function or action associated with the action key directly underneath the text appear in this line. Press the appropriate action key to access the function.

Remote Controls





MG-REM1

Remote Control Default Settings

Your installer can add other functions and/or change the default settings of your remote controls. To use the functions programmed in your remote control, press and hold the desired key(s) for at least two seconds. Your remote control has already been programmed with the following features:

 = Force Arm (page 10)

 = Disarm (page 12) / Control radio volume (page 20)

 = Turn FM radio ON/OFF* (page 19)†

 = Scroll through programmed radio stations in memory* (page 19)†

† = MG-REM1 only

* Available with the MG-6060 only

 = Request feedback from the Magellan system (see MG-REM2 Reference & Installation Manual for more information)‡

 = Turn FM radio ON/OFF* (page 19)‡

 = Scroll through programmed radio stations in memory* (page 19)‡

‡ = MG-REM2 only



MG-REM2

Magellan's Keypads

Main Keypad

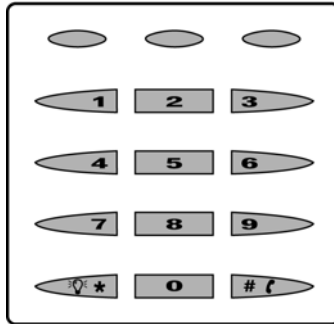

Use this keypad to enter User codes, required data and/or to select desired menus.

Center Keypad

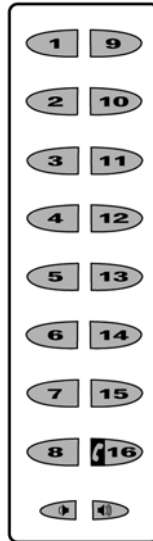

Use keys [1] to [16] on the center keypad for the following:

Zones 1 to 16*

OFF = Zone closed (ok)

ON = Zone opened

Flashing = The zone has been tampered with

Press once = Listen to zone's label (e.g.: "Front door")

* = *Press and hold key [16] to listen to the label for zone 16. See Key [16] below for more information.*

Users 1 to 16

When programming a user:

OFF = User not programmed

ON = User programmed

Press once = Listen to user label and program or edit a user

X10 programming**

This keypad is also used when programming and using Magellan's X10 features. Refer to *Magellan's X10 Instruction Guide* which can be downloaded for free from our website at www.paradox.ca.

Key [16]

Press once = Make a telephone call or answer an incoming call**. Press again to hang up. See page 21.

Press & hold = Listen to the zone label of zone 16.

Fast flashing = Speakerphone in use**. See page 21.

** Available with the MG-6060 only.

Chapter 2: Arming / Disarming

This chapter will cover the multiple arming methods that Magellan employs such as Regular arming and Stay arming. This chapter will also cover disarming the system, what to do during a fire alarm, fire safety tips and panic alarms.

Arming

When your system is armed, it can respond to any breach in the protected zones by generating an alarm and by transmitting a report to your monitoring station. Though the arming methods explained in this section pertain to arming through Magellan's keypad, the system can also be armed using your remote control. See *Remote Controls* on page 7.

Exit Delay Timer

When you arm your system, it will trigger the Exit Delay Timer to provide you with enough time to exit the protected area before your system is armed. You can program the Exit Delay Timer from 1 second to 255 seconds (default 45 seconds). *Only the System Master user can program the Exit Delay Timer.* To program the Exit Delay Timer:

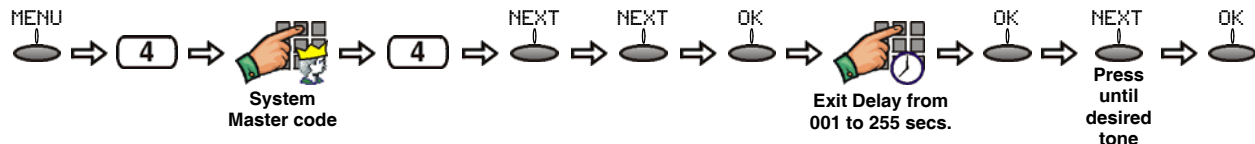

If a Delay zone is opened and then closed while the system is in Exit Delay mode, the Exit Delay timer will be reduced to 10 seconds. UL installations require a maximum exit delay of 60 seconds.

Regular Arming

This method is used for the everyday arming of your system. All defined zones in the system must be closed (the green **READY** light in ON) to Regular arm the system. To Regular arm your system:



Stay Arming

Stay arming will partially arm your system to permit you to remain in your home by arming the outer zones of your system (e.g. doors and windows) and ignoring interior zones (e.g. motion detectors). All defined zones in the system must be closed (the green **READY** light is ON) to Stay arm the system. To Stay arm your system:

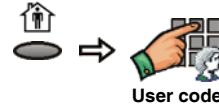

Instant Arming

This arming method is the same as Stay arming (page 10) except that the Entry Delay Timer (see page 12) is ignored. Therefore, any armed zone that is breached will immediately generate an alarm. To Instant arm your system:

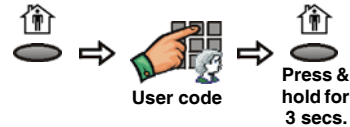

Force Arming

Force arming ignores open zones allowing you to arm your system. Once the zone closes, the system will then arm that zone as well. This feature is useful when a motion detector is protecting the area where your Magellan console is located. During Force arming, the motion detector will remain unarmed until you exit the area. The system will then arm the motion detector. By default, your system is programmed with this feature. You can also Force arm your system using your remote control (see page 7).

Please note that Force arming is not permitted in UL installations.

Bypass Programming

You can bypass certain zones when you arm the system. When a zone is bypassed, it will be ignored the next time you arm the system. Once the system is disarmed, the system will “unbypass” the zone. Zones that can be bypassed are defined by your installer. **Fire zones cannot be bypassed.** To bypass a zone:

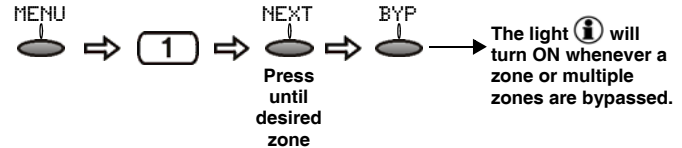



One-Touch Arming

If enabled by your installer, you can arm your system with the following arming methods simply by pressing and holding (for three seconds) the appropriate function key. You do not have to enter your User code. See Figure 1 on page 6 for the location of the function keys. Table 1 shows what function keys can be used for one-touch arming.

* To Instant arm your system using one-touch arming, press and hold the [STAY ARM] key and then during Exit Delay mode, press and hold the [STAY ARM] key once more.

Table 1: One-touch Arming Keys

Function Key	Arming Method
 key	Stay arm (page 10)
 key	Instant arm* (page 10)
 key	Regular arm (page 9)

Auto-Arming

You can set the time that the system will arm itself automatically. There are two methods of auto-arming:

Timed Auto-Arming

Your installer can set the Timed Auto-arming method to function in either Regular or Stay arming modes. A sixty-second Exit Delay sequence will begin prior to your system automatically arming itself at the programmed time. To set the Timed Auto-arming feature:

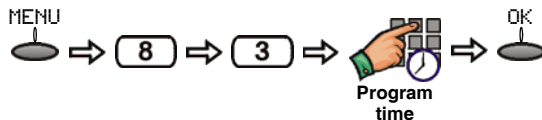

No Movement Auto-Arming

Your system can be programmed to send a report to your monitoring station and/or arm the system if there is no activity in the system during a specified period of time. Your installer can set No Movement Auto-arming to function in either Regular or Stay arming modes. Talk to your installer for more information.

Please note that Auto-arming is not permitted in UL installations

Disarming

When your system is disarmed, it deactivates any alarms in progress and it deactivates the zones so an alarm will not be triggered if zones are breached.

Entry Delay Timer

Your installer will program designated entry points (i.e., the front door) with an Entry Delay timer. This delay gives you time to enter the armed premises and enter your User code to disarm your system before the alarm is triggered. Up to two Entry Delay Timers can be programmed in your Magellan console.

Please note that UL installations require a maximum entry delay of 45 seconds.

Programming the Entry Delay Timer

Program the Entry Delay Timer with a value that will give you ample time to disarm your system before the alarm is triggered. *Only the System Master user can program the Entry Delay Timer.* To program the timer:

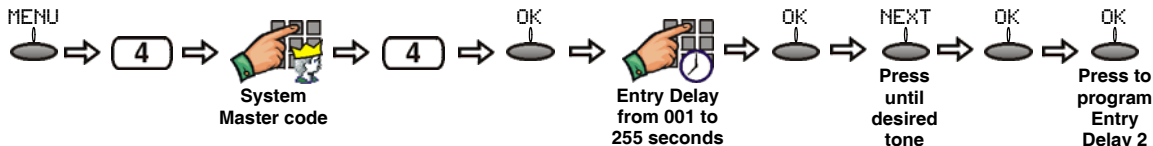

Disarming an Armed System

When an entry point, like the front door, is opened, Magellan will produce a sound indicating that the system has started the Entry Delay timer (page 12). If a valid User code is entered before the Entry Delay timer elapses, your system will disarm and will not generate an alarm. To disarm an armed system:

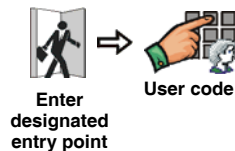

Disarming a System in Alarm

To disarm a system in alarm:



In the case of a burglar alarm, leave the premises immediately and call the police from a safe location (i.e., neighbour's).

Alarm Memory Display

When an alarm has occurred in your system, the Magellan console will store that alarm in its alarm memory. All zones where alarms have occurred will be stored in the alarm memory. The system will erase the contents of the alarm memory every time the system is armed. The Magellan console will indicate that there is an alarm in memory by illuminating the ⓘ light and by displaying the information symbol (see page 7) on the LCD screen. The alarm memory display can be viewed in two ways:

Through the Alarm Memory Menu

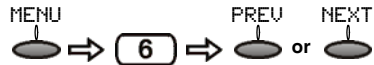

Use the [PREV] or [NEXT] action keys to scroll through available events.

After an alarm has occurred

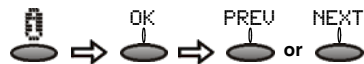

Use the [PREV] or [NEXT] action keys to scroll through available events.

Fire Alarms

For complete coverage in residential units, smoke detectors should be installed in the following locations:

- In any hallway outside bedroom areas. Additional detectors should be installed for every bedroom area as shown in Figure 2 on page 14.
- On every floor of a multi-floor home or apartment.
- At both ends of a bedroom hallway if the hallway is more than 12m (40ft) long.
- At the bottom of a basement stairwell.
- At the top of the first to second floor stairwell and subsequent stairwells in multi-floored residential units.

Figure 2: Single Residence with One or Two Sleeping Areas

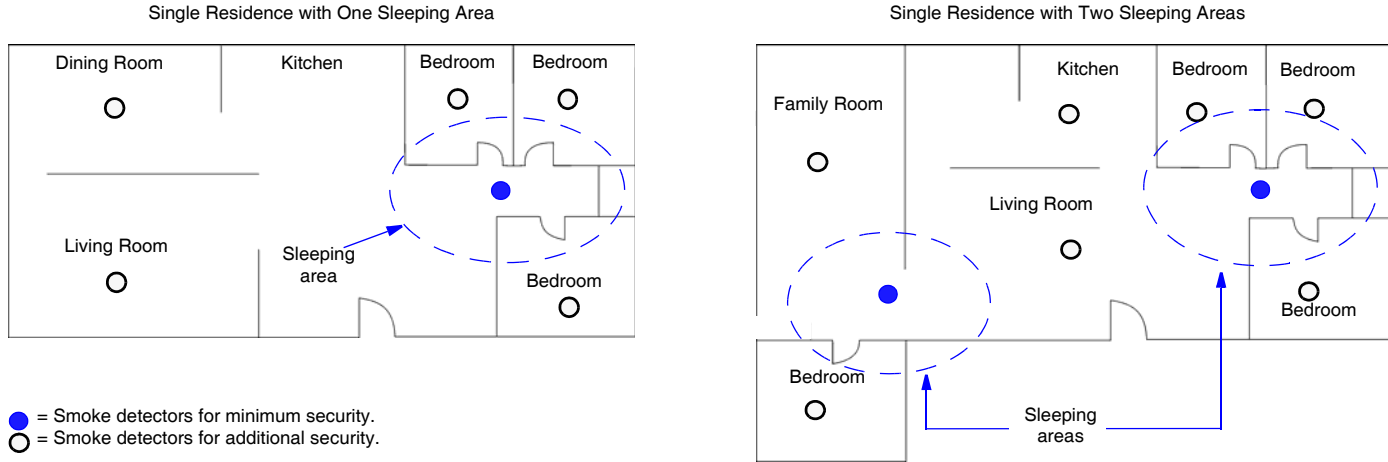

- = Smoke detectors for minimum security.
- = Smoke detectors for additional security.



Smoke detectors should be installed as close to the center of the ceiling as possible.

Standard Fire Zones

During a fire alarm, the siren emits an intermittent sound (BEEP-BEEP-BEEP) until silenced or reset. If the zone is a Standard Fire Zone, your system can immediately send an alert to your monitoring station. To disarm a false alarm:



Call your monitoring station quickly to advise them of the false alarm.

Delayed Fire Zones

If the zone is a Delayed Fire Zone, there is an automatic delay before your system contacts your monitoring station. Refer to Figure 3 on page 16 to prevent unnecessary reporting of false alarms. To clear a fire alarm triggered by accident:



If you are unable to cancel the false alarm, your system will send an alert. Call your monitoring station to advise them of the false alarm.

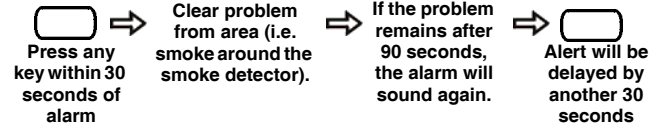

Fire Safety Tips

How should you prepare in case of a fire in your home or business?

- Remind everyone to escape first, and then call for help.
- Develop a fire escape plan and designate a meeting place outside.
- Practice the escape plan frequently.
- Plan two ways to escape from every room, if possible.
- Practice feeling the way out with eyes closed.
- Instruct everyone **never** to stand up during a fire. Always crawl under the smoke and keep mouths covered.
- Instruct everyone **never** to return to a burning building for any reason; it may cost them their life.
- Check smoke detectors regularly. Working smoke detectors dramatically increase everyone's chance of surviving a fire.

Minimizing Home Fire Hazards

How can you avoid the three most common causes of fires at home?

- Never leave cooking food unattended. It is the leading cause of fire injuries. Cooking fires often result from unattended cooking and human error, rather than mechanical failure.
- Stay alert when smoking. Careless smoking is the leading cause of fire deaths. Smoke detectors and smoulder-resistant bedding and upholstered furniture are significant fire deterrents.
- Maintain your heating system. Faulty heating systems are the second leading cause of residential fires.

Panic Alarms

Your system can be programmed to send an alarm to your monitoring station to request help from the police, a medical facility*, the fire department or anyone you wish when you press a pre-determined combination of keys on Magellan's main keypad. To generate a panic alarm, simultaneously press and hold the key combinations displayed in Figure 4 on page 17. Your installer can program the alarm to be either silent or audible.

* Programming your system to send an alarm to your Central Monitoring Station requesting help from a medical facility is not permitted in UL installations.

Figure 3: Delayed Fire Zone

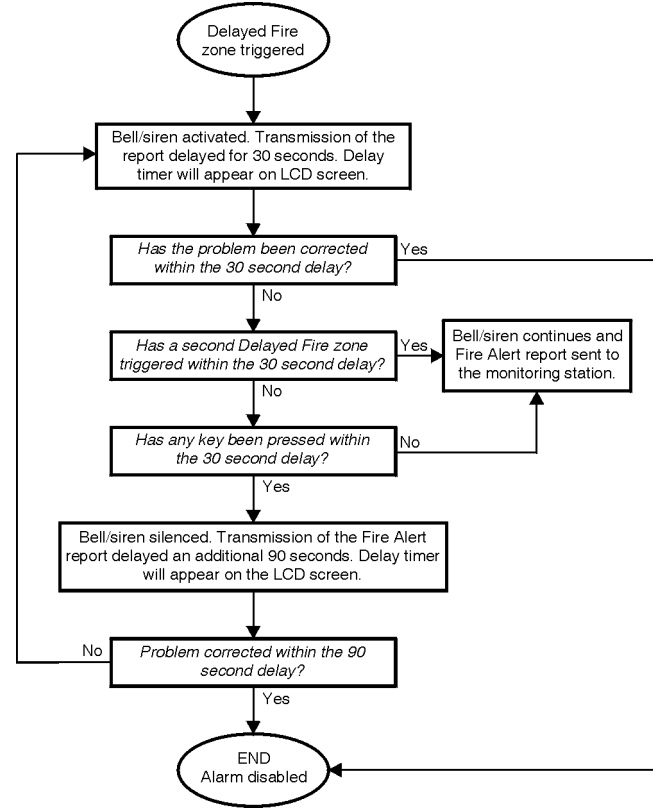
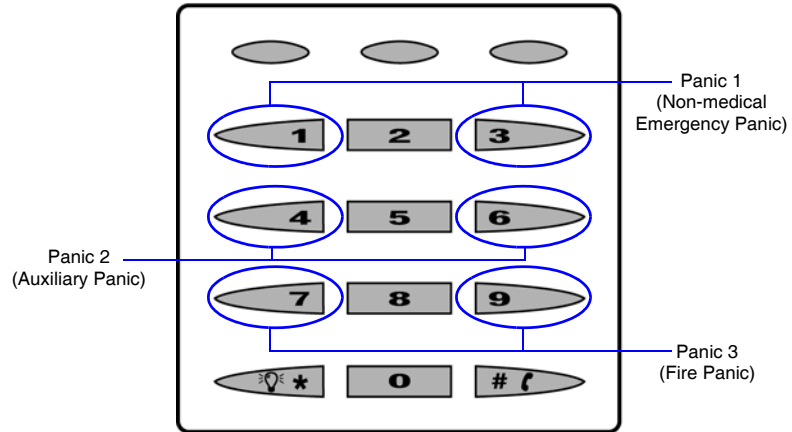

Figure 4: Panic Alarm Keys



Chapter 3: Consumer Features

This chapter will cover the other features that make Magellan a unique and wireless security system.

Message Center



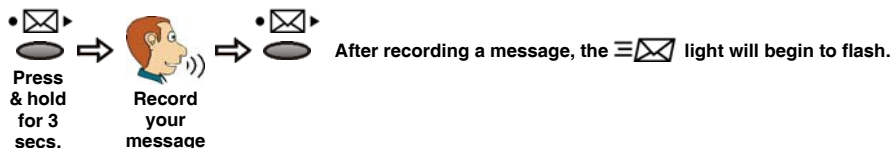

The Magellan console comes with a message center that allows you to record a voice message that can be played at a later time. This message center is useful when you need to leave a message for another member of your family or even for yourself.

Recording a Message

Perform the following to record a message:



Playing a Recorded Message

If the  light is flashing, there is a message recorded in the Magellan console. Press the  key to play the message. After the message is played for the first time, the  light will stop flashing. Although the  light has stopped flashing, the recorded message is still stored in the Magellan console. The message can be played at any time simply by pressing the  key. To record another message, please refer to *Recording a Message* above.



If you wish to record another message, the Magellan console will replace the old message with the new message. Only one message can be recorded and/or stored at a time.

FM Radio Feature (MG-6060 only)

The Magellan console incorporates a built-in radio. You can use this radio to listen to your favourite radio stations. You can also save up to 15 radio stations in memory.

Using the Radio

You can use the main keypad to enter the 4-digit frequency of the desired radio station or the [UP] action key to advance to the next available radio station. If no action is performed after a few seconds, the console will revert to its standby screen. Press the [FM] action key to return to the radio tuner screen. To use the radio:



Saving Radio Stations into Memory

Magellan can store up to 15 radio stations in memory. To store a radio station into memory:

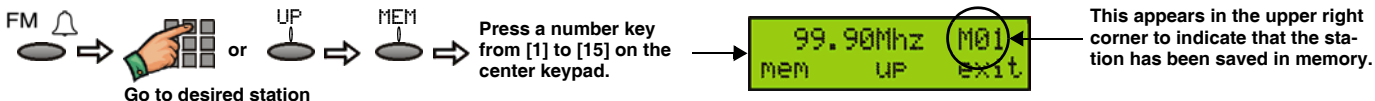

For example, to assign a radio station to memory location M01, access the radio station, press the [MEM] action key and then press the [1] key on the center keypad.



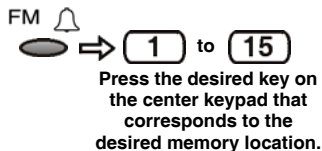

Retrieving Radio Stations from Memory

To retrieve a radio station saved in memory:



Accessing the Radio by Remote Control

By default, your remote control is programmed to manage Magellan's radio in the following ways:

- The  /  button on your remote control turns the radio ON/OFF. Press the button once to turn the radio ON and then press the button again to turn the radio OFF.
- The  /  button on your remote control scrolls through the radio stations saved in memory. Every time you press the button, Magellan will scroll to the next radio station saved in memory.
- The  button on your remote control adjusts the volume of the radio when the radio is already on and the system is disarmed. The volume of the radio will gradually increase to its highest possible volume and then decrease to its lowest possible volume.

Alarm Clock

You can also use the Magellan console as an alarm clock. At the programmed time, Magellan will begin to play a selected tone or activate the radio*. When the alarm clock is enabled, the alarm clock symbol (Figure 5) will appear in the upper left corner of the LCD screen.

Figure 5: Alarm Clock Symbol



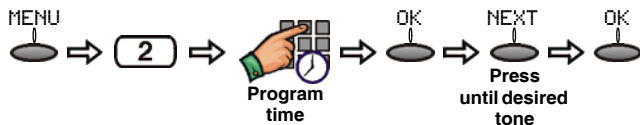

* Available with the MG-6060 only.

Setting the Alarm Clock Time



Using the Alarm Clock Feature

After programming the alarm clock, the feature will be enabled and Magellan will play the selected tone at the programmed time. Please note the following:

- When the alarm clock activates, press the [SNOOZE] action key or press any button on the Magellan console to enable the snooze feature. The alarm clock will wait ten minutes before activating again.
- Press and hold the FM  key or press the [OFF] action key to disable the alarm clock. To enable the alarm clock again, press and hold the FM  key. The alarm clock symbol will appear on the LCD screen.
- Press the [STOP] action key to turn OFF but not disable the alarm clock. The alarm clock will reactivate the following day at the programmed time.
- If you have not activated the snooze or disabled the alarm clock, the alarm clock will stay ON for one hour if AC power is present.

Speakerphone (MG-6060 only)

Magellan comes with a feature that transforms the console into a speakerphone. Simply dial the desired telephone number and talk as you would on a normal telephone. You can also configure the ring tone and volume for incoming telephone calls. When the console's speakerphone is being used, the console will emit a tone and key [16] on the center keypad will flash rapidly (see *Magellan's Keypads* on page 8).

Making a Standard Telephone Call through the Console

Using the center keypad:

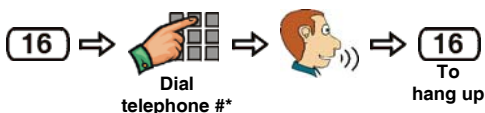

* When using the center keypad

to dial the telephone number:

Keys [1] to [9] = 1 to 9

Key [10] = 0

Key [11] = *

Key [12] = #

Answering an Incoming Call

Using the center keypad:



Setting the Ring Tone and Volume

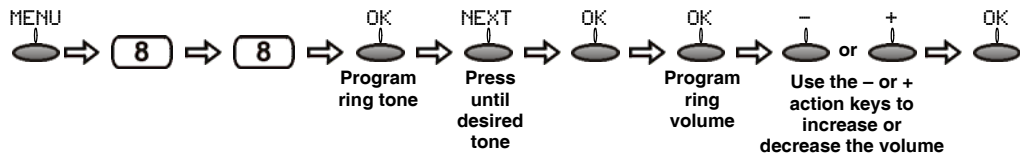

Chime Zones

You can program the console to emit a tone whenever designated zones are opened. These zones are referred to as Chime zones.

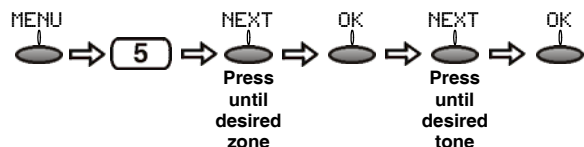

Keypad Settings

You can modify the console's backlight and the LCD screen's contrast to suit your needs.

Adjusting the Backlight

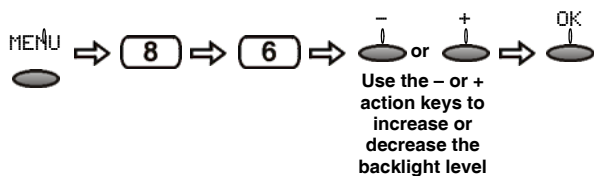

Adjusting the LCD Screen's Contrast

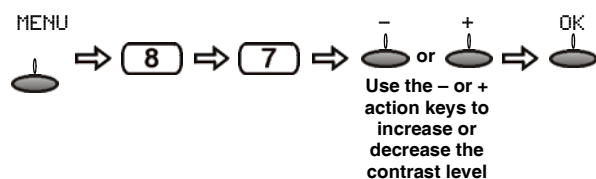

Time and Date

To set the time and date of your Magellan console:

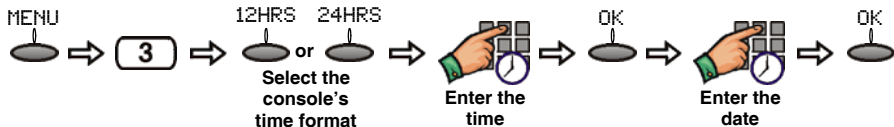

Programmable Outputs (PGMs)

The Magellan console includes four programmable outputs (PGMs). When a specific event or condition occurs in the system, the PGM can be used to activate light switches, open/close a garage door and much more. Talk to your installer about this useful feature.

Programmable Output (PGM) Labels

To modify your PGM labels:

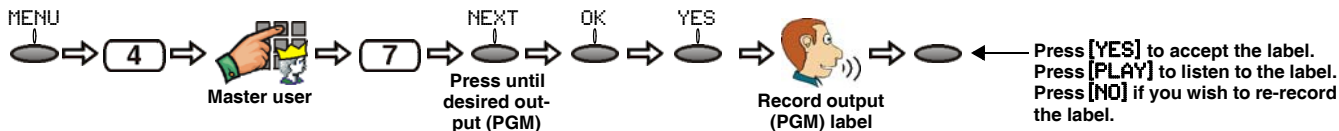

Trouble Display

If your system experiences any problems, the information symbol will appear on the LCD screen and the ⓘ light will be ON. Use the Trouble Display to view what troubles your system is experiencing. If an alarm has occurred in the system, the information screen will first display the alarm memory. See *LCD Screen* on page 7. To access the Trouble display:

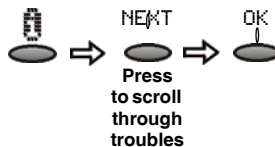

If any troubles occur, we strongly recommend that you contact your installer immediately to have your system serviced. To call for service, refer to Making a Service Call (MG-6060 only)

Making a Service Call (MG-6060 only)

When certain troubles occur, you can call for service using the Magellan console. The Trouble Display has a feature that can be used to contact your installer. The telephone number will already be programmed in your Magellan console by your installer. To make a service call:

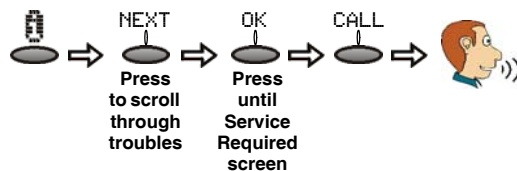

Demo Mode

Use this mode to preview the Magellan console's features. After entering Demo Mode, the Magellan console will begin displaying its features by flashing its lights, playing tones, etc. To access Demo Mode:

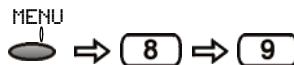

When in Demo mode, the Magellan console's speaker and siren will also be played. Do not stay in close proximity to the console to avoid damaging your hearing.

X10 Automation (MG-6060 only)

The Magellan console supports X10 automation. X10 is a communication protocol for remotely controlling electrical devices such as lamps and appliances. Communication is accomplished through standard household electrical wiring using X10 Transmitters and receivers. For more information on programming and using X10 with the Magellan console, download and/or refer to the Magellan X10 *Operation User Guide* from our website at www.paradox.ca.

Chapter 4: Access System Features by Phone (MG-6060 only)

This chapter covers Magellan's remote access feature that transforms any external touch-tone telephone into a keypad. Through the telephone, you will be able to arm/disarm your system, listen to any messages, activate outputs and more.

Access System Features by Phone

Due to Magellan's voice-assisted remote features, any touch-tone telephone can be turned into a keypad. Arm/disarm Magellan, activate/deactivate Magellan's PGM outputs, record/listen to messages and even turn Magellan into a speakerphone all via your telephone. Using detailed voice prompts to guide your way, remote access to Magellan is as easy as picking up the telephone.



Please note the following:

- The following instructions pertain to entering commands and/or data through your telephone's keypad. Therefore, whenever you are instructed to perform an action and/or enter data, do so on your telephone's keypad.
- Magellan will automatically hang up if no action is performed after 2 minutes.
- Press the [*] key at any time to exit and have Magellan hang up.
- When Magellan is in speakerphone mode, key [16] on the center keypad will flash rapidly.

Step 1: Call Magellan from any touch-tone telephone

Pick up your telephone and dial the number of the telephone line that your Magellan console is connected to (usually your home number). If the telephone line that Magellan is connected to is shared with an answering service or answering machine, you have to override the answering service or machine. To override the answering service or machine:

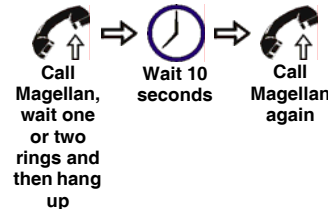

Step 2: Enter your user code

Use the same User code that you use with the Magellan console.

Step 3: Select an action

Arm/Disarm:

Pressing the [1] key toggles the system between armed and disarmed states. If your system is disarmed, press the [1] key to arm your Magellan console. If your system is armed, press the [1] key to disarm your system.

Speakerphone Mode:

Press the [4] key to convert your Magellan console into a remote speakerphone. You can listen in at your home and/or speak to someone already there. The person you are talking to can hang up by pressing the [16] key on the center keypad on the console. You hang up by pressing the [*] key. Press the [#] to exit speakerphone mode and to continue through the menu.

Activate/deactivate PGM1:

Press the [5] key to activate or deactivate the Magellan console's PGM output 1 (page 23).

Exit Menu or Hang up:

Press the [*] key to either exit a menu or to hang up with your Magellan console.

Record a Message:

Press the [2] key to record a message in the Magellan console's message center (page 18). *Please note that the message cannot exceed 20 seconds in length. Press the [*] key to stop recording at any time.*

Listen to message:

Press the [3] key to listen to a message already in the Magellan console's message center (page 18).

Activate/deactivate PGM2:

Press the [6] key to activate or deactivate the Magellan console's PGM output 2 (page 23).

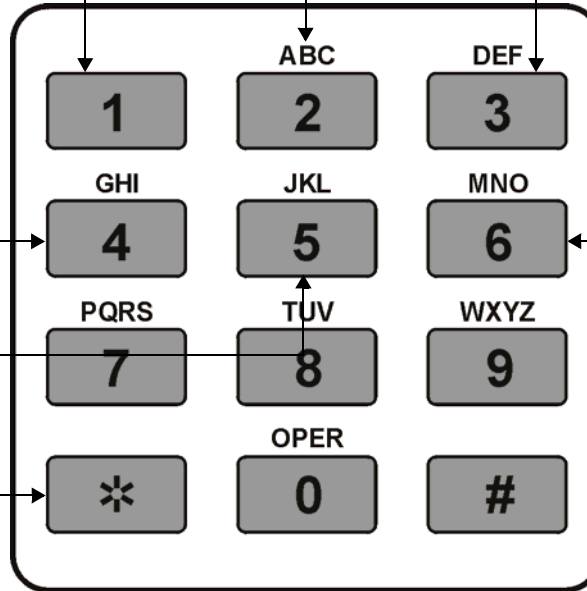

Chapter 5: Advanced Features

This chapter pertains to features and functions that only the System Master user can access.

This chapter covers User code programming, such as programming new users into the system. This chapter also covers some zone features as well as instructions on how to customize Magellan to suit your needs.

Programming User Codes

User codes allow access to the system. Magellan supports up to 16 User codes where:

- Every user from 002 to 016 is assigned a User code (user 001 is the System Master).
- Your installer can program User codes to be four or six digits in length.
- Each digit can be any value from 0 to 9.

To create or modify a user:

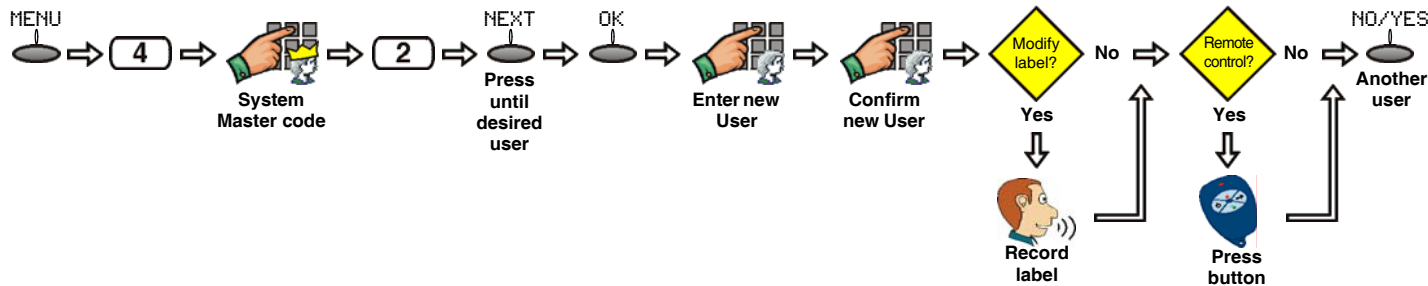

System Master Code (default: 1234)

The System Master code will give you access to all of the features available on your system as well as the ability to add, modify, or delete any users.



It is recommended that you change the default System Master code to a code of your choosing. This will prevent unauthorized users from accessing and modifying options.

Duress User Code

If enabled by your installer, User code 016 can be programmed as a Duress code. If you are forced to arm or disarm your system, entering the user code for User 016 will arm or disarm your system and immediately transmit a silent alarm (Duress code) to your monitoring station.

Deleting a User

When you delete a user, the remote control that is assigned to that user will also be deleted. To delete an existing user:

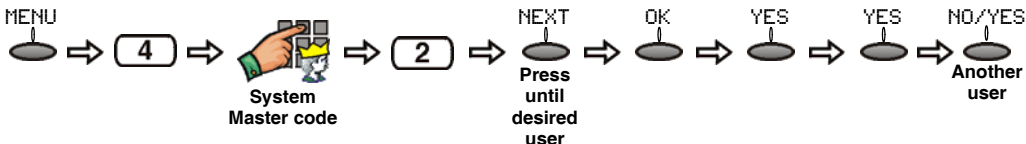

The System Master user cannot be deleted.

Adding a Remote Control to an Existing User

To add a remote control to a user that is already programmed in the Magellan system:

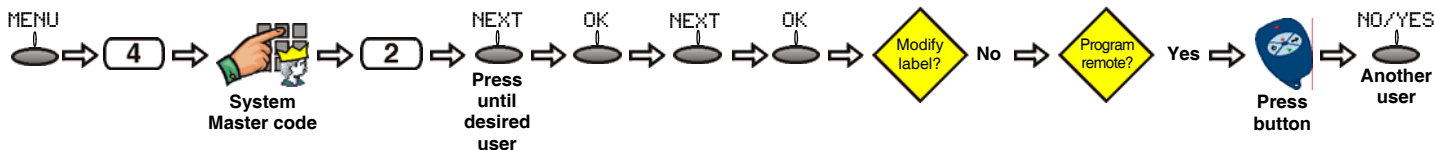

Deleting a Remote Control

To delete a remote control that is already programmed in the Magellan system:

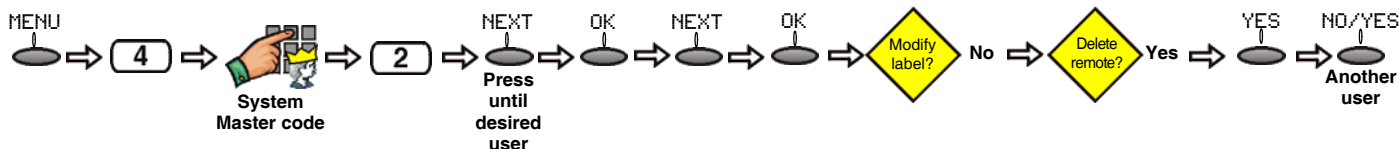

Setting the Language

By default, Magellan is set to English. To change the language:

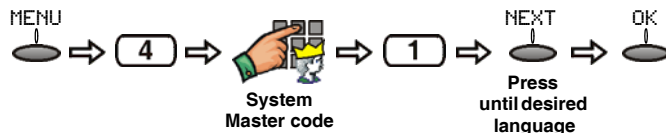

Voice Reporting

Use the Magellan console to call you (or someone you choose) on up to two different telephone numbers and play a personalized voice message (maximum 20 seconds in length) to announce that an alarm has occurred. After receiving the message, press the [#] key on the telephone twice to acknowledge and end the message. The unit will call eight times (switching between both numbers) or until someone acknowledges the message. Press the [1] key on the telephone to use the speakerphone feature and to talk through the Magellan console. To program the Magellan console for voice reporting:

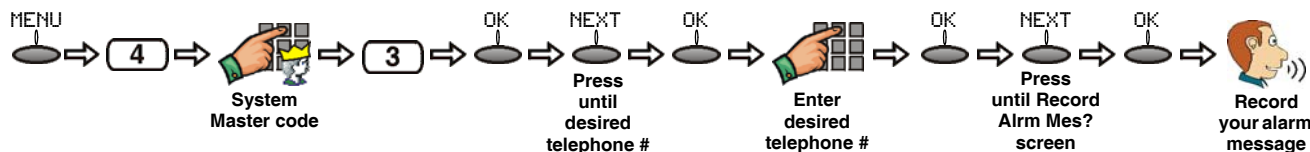

Example: You programmed Magellan's Voice Reporting feature to call your cellular phone and play your recorded message, "There is an alarm occurring at home." Therefore, whenever an alarm occurs, Magellan will call you on your cellular phone and you will hear "There is an alarm occurring at home". Press the [#] key on your cellular phone to acknowledge the message.

Utility Reporting

Customize which events and when these events will be reported to you by using the Utility Reporting menu. Program from one of four report types to have the Magellan console call you when certain conditions are met. With this feature programmed, Magellan will call up to two separate telephone numbers and play a personalized pre-recorded voice message. After receiving the message, press the [#] key on the telephone twice to acknowledge and end the message. Press the [1] key on the telephone to use the speakerphone feature and to talk through the Magellan console. To program the Utility Reporting feature:

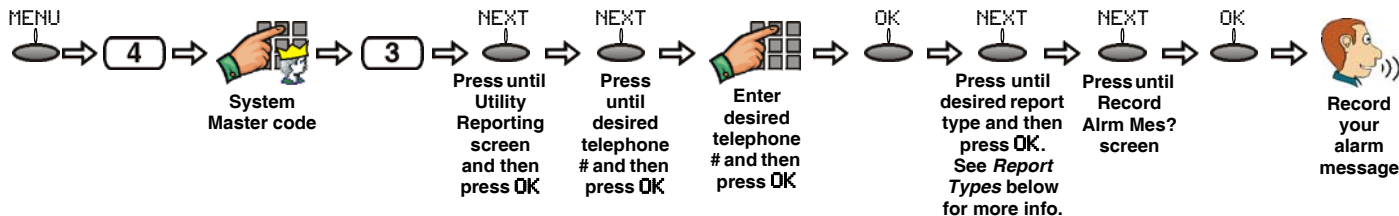

Report Types

There are four report types that can be used with Utility reporting:

- *Disarm with user:* Use this report type to program the Magellan console to call you when specific users disarm the system. After entering the menu, select the desired user(s) that you wish reported. This feature is useful when you wish to know when specific people disarm the system.
For example, you can program Magellan to call you whenever your children disarm your system thus informing you that they have arrived home.
- *System troubles:* Use this report type to have the Magellan console call you when specific troubles occur. After entering the menu, select the desired trouble(s) you wish to be notified about. This feature can be used to inform you of a power failure.
- *Non-medical Emergency alarm:* Use this report type to have the Magellan console call you when specific users require non-medical emergency assistance. When the programmed users press the appropriate key on their remote controls (see *Remote*

Controls on page 7), the Magellan console will make a buzzing sound and then call one or both programmed telephone numbers. After entering the menu, select the desired user(s) that you wish reported. *For example, if there is an elderly parent who lives in your home, you can program Magellan to call you whenever they require assistance. All they have to do is press the appropriate button on their remote control.*



One of the user's remote control buttons must be programmed with the Non-medical Emergency alarm option in order for the Non-medical Emergency alarm to function. Talk to your installer about this feature.

- Zone activation:** When a specified zone is breached or opened, the Magellan console will call one or both of the programmed telephone numbers. After entering this menu, select the desired zones you wish affected. Use this feature to be informed when a specific zone is breached. *For example, if you have a gun closet at home, you can have Magellan call you whenever the gun closet is opened or breached.*

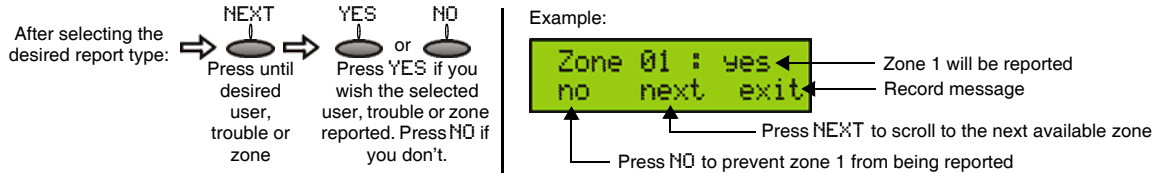

Pager Reporting

Transmit personalized numerical messages from the Magellan console to a pager using this communicator format. To program the Magellan console with this communicator setting:

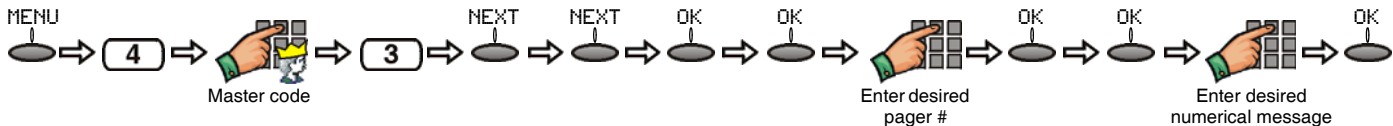

Bell Cut-Off Timer

After an audible alarm, Magellan's built-in siren will stop upon the disarming of the system or when the Bell Cut-off Timer has elapsed, whichever comes first. To program the Bell Cut-off Timer:

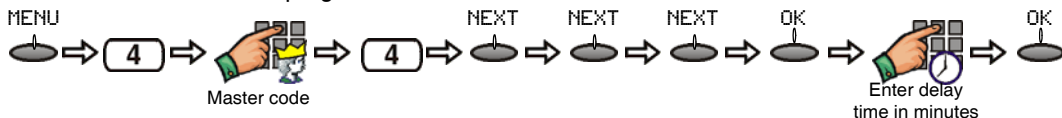

For UL installations, the Bell Cut-off Timer must be set to 4 min. minimum. For cUL, the Bell Cut-off Timer must be set to 5 min. minimum.

System Test

This menu will initiate tests for Magellan's assigned zones, remote controls, reporting feature as well as some of Magellan's hardware (lights, speaker and siren). This menu will also display any troubles that the system may be experiencing. Use the **[NEXT]** action key to scroll through the available system tests and then press the **[OK]** action key to access the desired test. Simply follow the on-screen instructions to perform the test. To access the System Test menu:

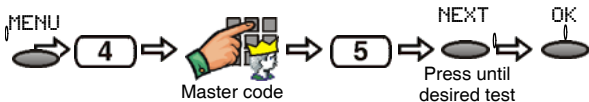

When testing the hardware, the speaker and sirens will also be tested. Do not be in close proximity to the Magellan console when performing the hardware test to avoid any damage to your hearing.

Zone Labels

You can record a custom voice label for one or all of the available zones in your system. By default, each zone has a pre-recorded label that simply states the zone number. For example, zone 1's default label is "zone one". Use this menu feature to apply labels of your choosing for each available zone. You can use labels such as "Front Door" or "Basement", etc. To record a zone label:

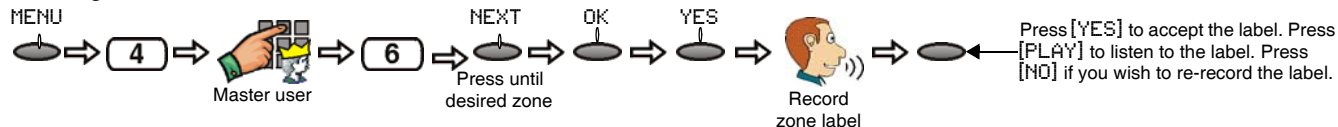

Index

A

Accessing system features by phone	25
Accessing the radio by remote	20
Action key	6
Adding a remote control	28
Alarm clock	
<i>Configuring</i>	20
<i>Disabling</i>	21
<i>Enabling</i>	21
<i>Snooze</i>	20
<i>Using</i>	20
Alarm clock/Radio tuner key	6
Alarm memory display	13
Alarms	
<i>Disarming</i>	13
<i>Fire</i>	13
<i>Panic</i>	16
Armed light	6
Arming methods	
<i>Auto-arming</i>	11
<i>Force arming</i>	10
<i>Instant arming</i>	10
<i>One-touch arming</i>	11
<i>Regular arming</i>	9
<i>Stay arming</i>	10
Auto-arming	
<i>No Movement auto-arming</i>	11
<i>Timed auto-arming</i>	11

B

Backlight	22
Basic Operation	6
Bypassing zones	10

C

Center keypad	6, 8
Center, Message	18
Chime zones	22
Clock, alarm	20
Contrast	22

D

Date and time	23
Delayed fire zones	15
Deleting	
<i>Remote Controls</i>	29
<i>Users</i>	28
Demo mode	24
Disarming	12
<i>System in alarm</i>	13
Display	
<i>Alarm memory</i>	13
Display, Trouble	23
Duress user code	28

E

Entry delay timer	12
Exit delay timer	9

F

Fire alarms	
<i>Delayed fire zones</i>	15
<i>Fire safety tips</i>	15
<i>Minimizing home fire hazards</i>	16
<i>Residential installations</i>	13
<i>Standard fire zones</i>	14
Fire hazards, minimizing	16
Fire zones	
<i>Delayed fire zones</i>	15
<i>Standard fire zone</i>	14
FM radio feature	19
Force arming	10
Function keys	6

H

Home, Minimizing fire hazards	16
How to use the User Guide	4

I

Indicators, light	6
Information	
<i>Light</i>	6

<i>Symbol</i>	7	Making a Service Call	24	Programmable outputs	23
Instant arming	10	Master code	27	Programming	
K		Memory display, Alarm	13	<i>Date</i>	23
Keypad settings	22	Memory, radio	19	<i>Time</i>	23
Keys		Message		<i>User codes</i>	27
<i>Action keys</i>	6	<i>Key</i>	6	R	
<i>Alarm clock/Radio Tuner key</i>	6	<i>Light</i>	6	Radio	
<i>Function keys</i>	6	Message center		<i>Accessing by remote control</i>	20
<i>Message key</i>	6	<i>Playing a recorded message</i>	18	<i>Retrieving stations from memory</i>	19
<i>Regular arm key</i>	6	<i>Recording a message</i>	18	<i>Saving radio stations into memory</i>	19
<i>Stay arming key</i>	6	Minimizing home fire hazards	16	<i>Tuner</i>	19
<i>Volume keys</i>	6	N		<i>Using the radio</i>	19
L		No movement auto-arming	11	Ready light	6
Labels		O		Recording a message	18
<i>User</i>	27	One-touch arming	11	Regular arm key	6
<i>Zone</i>	32	Operation, basic	6	Remote access by phone	25
Language, Setting	29	Outputs, programmable	23	Remote controls	7
LCD screen	6, 7	P		<i>Adding</i>	28
<i>Backlight</i>	22	Pager Reporting	31	<i>Deleting</i>	29
<i>Contrast</i>	22	Panic alarms		Report Types	30
Light indicators		<i>Auxiliary panic</i>	16	Reporting	
<i>Armed light</i>	6	<i>Emergency</i>	16	<i>Pager</i>	31
<i>Information light</i>	6	<i>Emergency panic</i>	16	<i>Utility</i>	30
<i>Message light</i>	6	<i>Fire panic</i>	16	<i>Voice</i>	29
<i>Ready light</i>	6	PGMs	23	Ring tone	22
M		Playing a recorded message	18	Ring volume	22
Main keypad	6, 8	S		Safety, Fire tips	15

Saving radio stations	19	Utility Reporting	30
Service Call	24	V	
Setting the Language	29	Voice Reporting	29
Settings, keypad	22	Volume	22
Speakerphone		<i>Volume key</i>	6
<i>Configuring</i>	22	X	
<i>Using</i>	21	X-10 automation	24
Standard Fire Zone	14	Z	
Stations, radio	19	Zone	
Stay arming	10	<i>Bypassing</i>	10
<i>Stay arming key</i>	6	<i>Chime</i>	22
System master code	27	<i>Delayed fire zones</i>	15
T		<i>Labels</i>	32
Time and date	23	<i>Standard Fire zone</i>	14
Timers			
<i>Entry delay</i>	12		
<i>Exit delay</i>	9		
Tips, Fire safety	15		
Tone, ring	22		
Trouble Display	23		
Tuner, radio	19		
U			
User codes			
<i>Adding a remote control</i>	28		
<i>Deleting</i>	28		
<i>Duress</i>	28		
<i>Programming</i>	27		
Using the User Guide	4		

Warranty

Paradox Security Systems Ltd. ("Seller") warrants its products to be free from manufacturing defects in materials and workmanship for one-year following the date of manufacture. Seller will, within this period, at its option, repair or replace any product failing to operate correctly without charge to the original purchaser or user. This warranty will not apply to any equipment, or any parts thereof, which have been repaired by others, improperly installed, improperly used, abused, altered, damaged, subjected to acts of God, or on which any serial numbers have been altered, defaced or removed. Seller will not be responsible for any dismantling or reinstallation charges.

THERE ARE NO WARRANTIES, EXPRESS OR IMPLIED, BEYOND THE DESCRIPTION HEREIN. THERE IS NO EXPRESS OR IMPLIED WARRANTY OF MERCHANTABILITY OR A WARRANTY OF FITNESS FOR A PARTICULAR PURPOSE. THIS WARRANTY IS IN LIEU OF ALL OTHER OBLIGATIONS OR LIABILITIES ON THE PART OF SELLER, ITS SUPPLIERS AND/OR AFFILIATES.

Any action for breach of warranty, including but not limited to any implied warranty of merchantability, must be brought within three months following the end of the warranty period. IN NO CASE WILL SELLER OR ITS AFFILIATES BE LIABLE TO ANYONE FOR ANY CONSEQUENTIAL OR INCIDENTAL DAMAGES FOR BREACH OF THIS OR ANY OTHER WARRANTY, EXPRESS OR IMPLIED, EVEN IF THE LOSS OR DAMAGE IS CAUSED BY THE SELLER'S OWN NEGLIGENCE OR FAULT.

In case of defect, contact the security professional who installed and maintains your security system. In order to exercise the warranty, the product must be returned to the indicated RMA location by the security professional, shipping costs prepaid and insured. After repair or replacement, Seller assumes the cost of returning products under warranty. Seller will have no obligation under this warranty, or otherwise, if the product has been repaired by others, improperly installed, improperly used, abused, altered, damaged, subjected to accident, nuisance, flood, fire or acts of God, or on which any serial numbers have been altered, defaced or removed. Seller will not be responsible for any dismantling, reassembly or reinstallation charges.

This warranty contains the entire warranty. Any prior agreements or representations, whether oral or written, are either merged herein or are expressly cancelled. Seller neither assumes, nor authorizes any other person purporting to act on its behalf to modify, to change, or to assume for it, any other warranty or liability concerning its products.

Notwithstanding anything herein, in no event shall Seller or its affiliates be liable for an amount in excess of Seller's original selling price of the product, for any loss or damage, whether direct, indirect, incidental, consequential or otherwise arising out of any failure of the product. Seller's warranty, as hereinabove set forth, shall not be enlarged, diminished or affected by and no obligation or liability shall arise from Seller offering to render or rendering technical advice or services in connection with the purchase of goods hereunder.

SELLER STRONGLY RECOMMENDS THAT THE ENTIRE SYSTEM BE COMPLETELY TESTED MONTHLY.

Warning: Despite frequent testing, and due to, but not limited to, any or all of the following: criminal tampering, electrical or communication disruption, or improper use, it is possible for the system to fail to perform as expected. Seller does not represent that the product/system may not be compromised or circumvented or that the product or system will prevent any personal injury or property loss by burglary, robbery, fire or otherwise; nor that the product or system will in all cases provide adequate warning or protection. A properly installed and maintained alarm may only reduce risk of burglary, robbery, fire or otherwise but it is not insurance or a guarantee that these events will not occur. **CONSEQUENTLY, SELLER SHALL HAVE NO LIABILITY FOR ANY PERSONAL INJURY, PROPERTY DAMAGE, OR OTHER LOSS BASED ON A CLAIM THE PRODUCT FAILED TO GIVE WARNING.** Therefore, the installer should in turn advise the consumer to take any and all precautions for his or her safety including, but not limited to, fleeing the premises and calling 911, the police and/or fire department, in order to mitigate the possibilities of harm and/or damage. Seller is not an insurer of either the property or safety of the user's family or employees, and limits its liability for any loss or damage including incidental or consequential damages to Seller's original selling price of the product in question, regardless of the cause of such loss and/or damage.

Some locations do not allow limitations on how long an implied warranty lasts or do not allow the exclusion or limitation of incidental or consequential damages, or differentiate in their treatment of limitations of liabilities for ordinary or gross negligence, therefore the above limitations may be reduced and/or not apply to you. This warranty gives you specific legal rights and you may also have additional rights depending on the location.

© 2004-2005 Paradox Security Systems Ltd. All rights reserved. Specifications may change without prior notice. One or more of the following US patents may apply: 6215399, 6111256, 5751803, 5721542, 5287111, 5119069, 5077549, 5920259, 5886632. Canadian and international patents may also apply. Magellan is a trademark or registered trademark of Paradox Security Systems Ltd. or its affiliates in Canada, the United States and/or other countries.

MAGELLAN-EU05

Choose from



The Digital Dual-Optic High-Performance Outdoor PIR (40kg/90lb True Pet Immunity) (MG-PMD85),

Digital Dual-Optic High-Performance PIR (40kg/90lb True Pet Immunity) (MG-PMD75) or,

the Analog Single-Optic PIR (18kg/40lb Pet Immunity) (MG-PMD1P)



2-Way Wireless PGM (MG-2WPGM)



The 2-Way Remote Control with Backlit Buttons (MG-REM2) or, the Remote Control with Backlit Buttons (MG-REM1)



Choose from

The Door Contact (MG-DCTXP),

Ultra-Small Door Contact (MG-DCT2) or,

the Long-Range Door Contact (MG-DCT1)



Smoke Detector (SD738)
Made by EVERday (Taiwan)†

† manufactured and available exclusively through EVERday Technology Co. Ltd.



780 Industriel Blvd., Saint-Eustache (Quebec) J7R 5V3 CANADA

www.paradox.ca